

Wireless Charging Tray  
 Seat Leon (5F) 11/2012-10/2016\*

241328-50-1

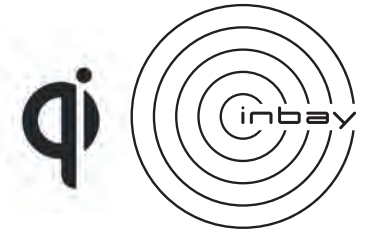

\* Nur kompatibel mit Modellen, die mit diesem Ablagefach ausgestattet sind. (siehe Beispielfoto)

\* Only compatible with models equipped with this pocket. (see sample photo)



**D EINBAUANLEITUNG**

**GB INSTALLATION GUIDE**

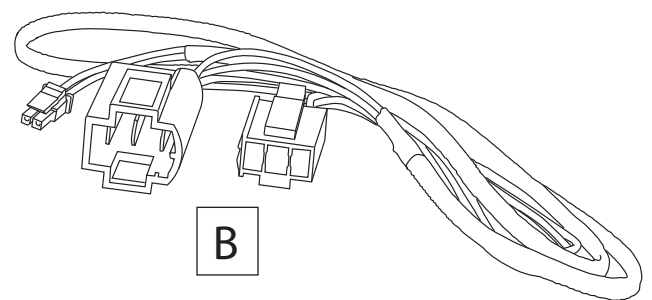
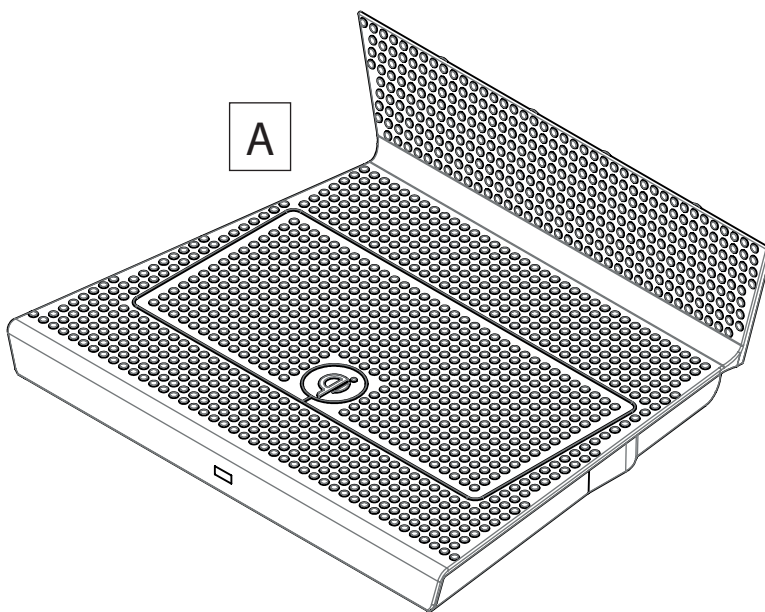

www.inbay.systems



Einbauvideo · Install video  
[www.inbay.systems/videos](http://www.inbay.systems/videos)

Sachgemäße Installation unter Beachtung dieser Einbauanleitung erforderlich. Achten Sie auf korrekte Anschlüsse. Verlegen Sie die Kabel so, dass Sie weder geknickt, gequetscht oder beschädigt werden können. Sorgen Sie dafür, dass sich die Kabel nicht in Gegenständen verfangen können.

Wir können keine Haftung für Schäden übernehmen, welche durch unsachgemäße Installation oder Nutzung verursacht wurden. Verwenden Sie darum ausschließlich das mitgelieferte Montagematerial.

Technische Änderungen vorbehalten, alle Angaben ohne Gewähr.

Das „Qi“ Logo ist Warenzeichen des „Wireless Power Consortium“

An appropriate installation in observance of these operating instructions is necessary. Please make sure the wiring is arranged so it is not bended or crimped due to the risk of cable break. Make sure that all connections are correct. Route the cable away from moving parts, do not allow the cable to be entangled, pinched or damaged in any way.

We will not be liable for damage due to improper installation or utilization. Use the specified accessory parts to prevent product failure.

Subject to technical modifications; no responsibility is accepted for the accuracy of this information.

The “Qi” symbol is a trademark of the “Wireless Power Consortium”











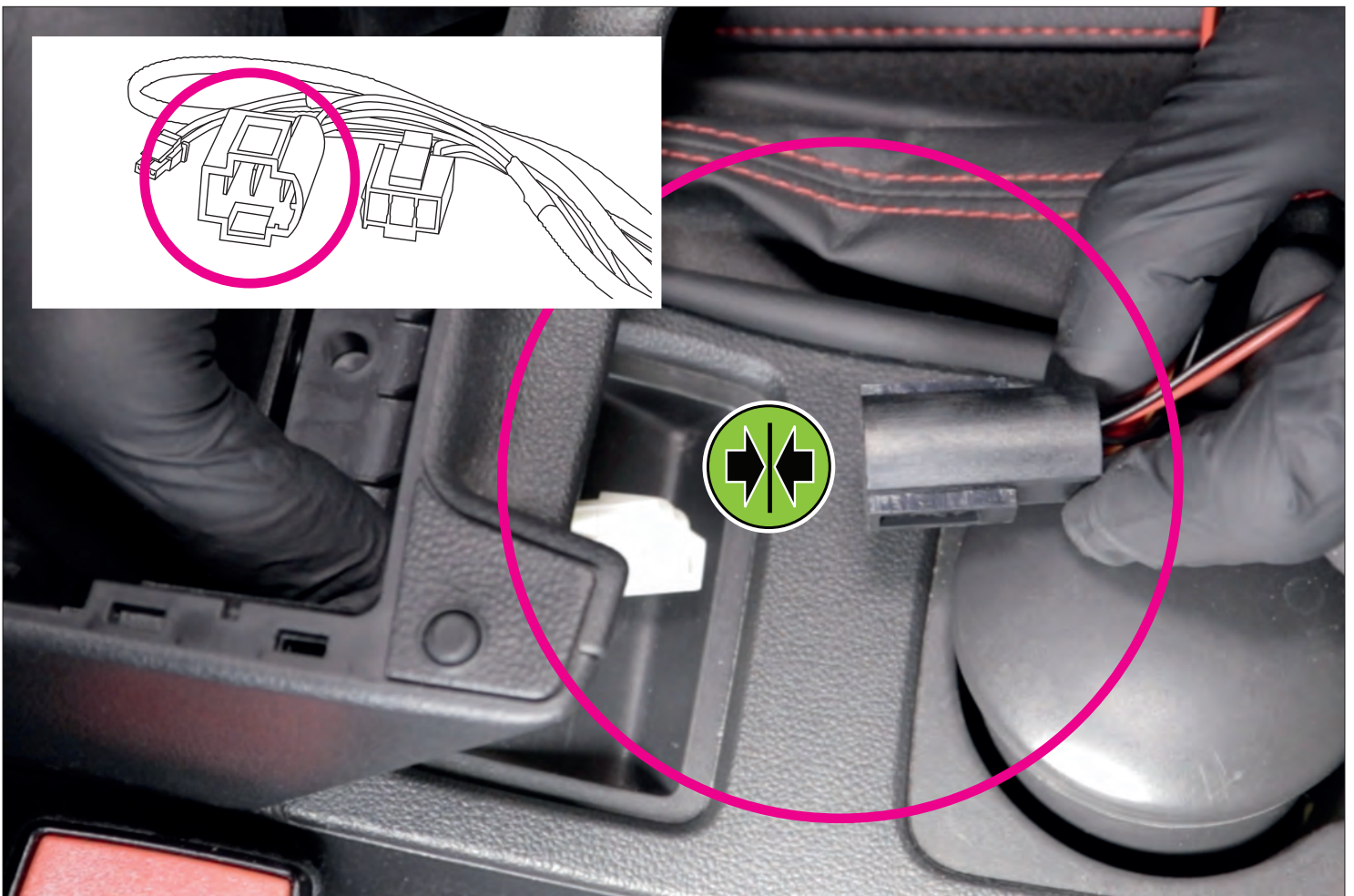
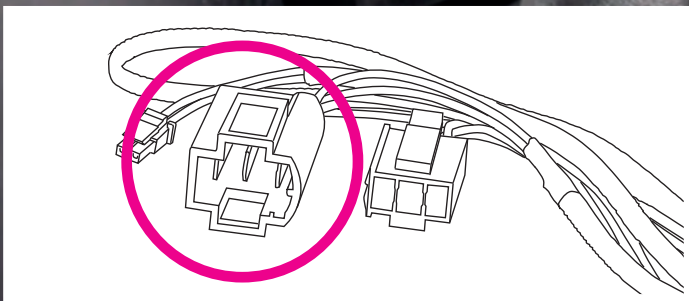
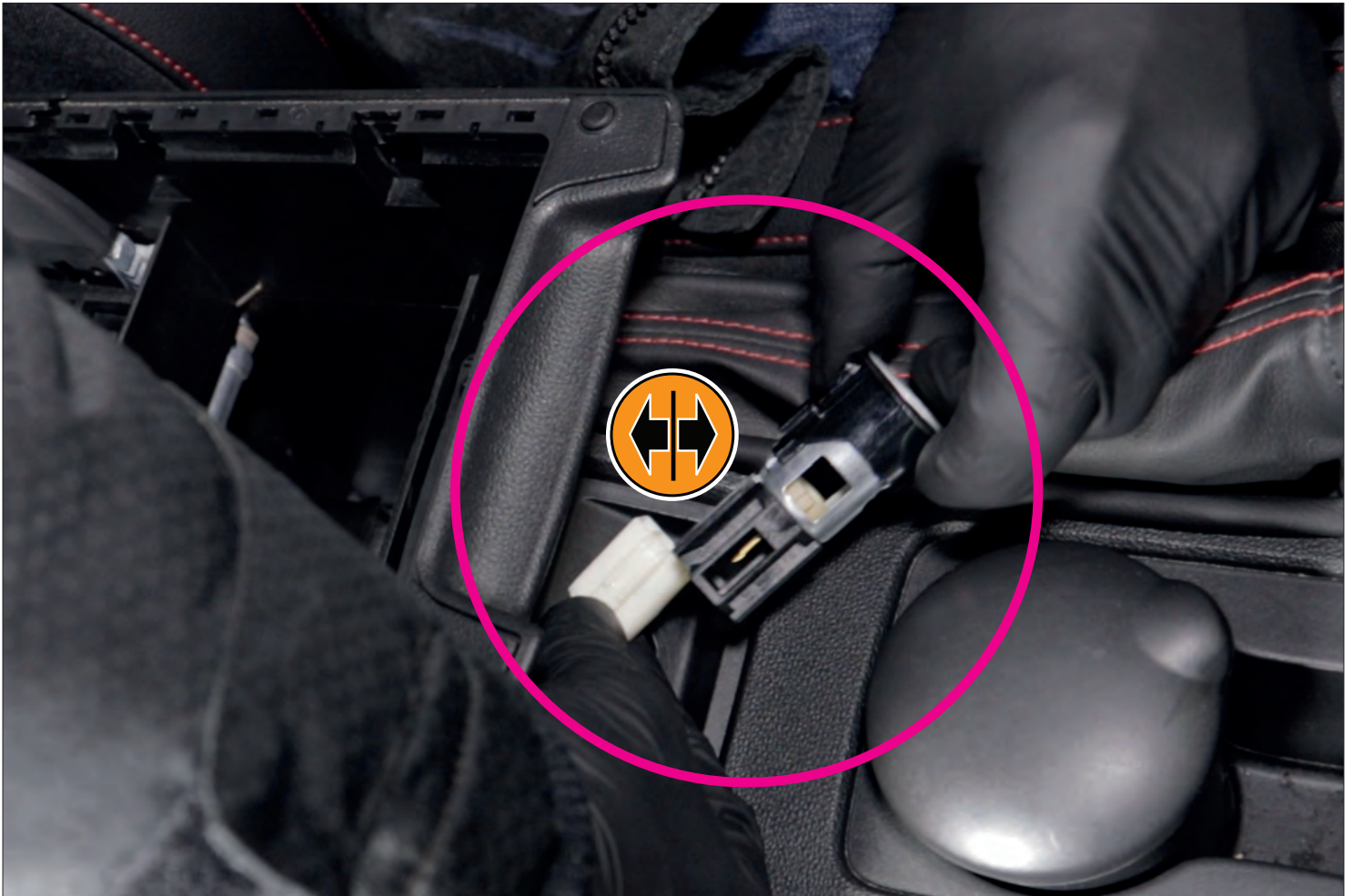

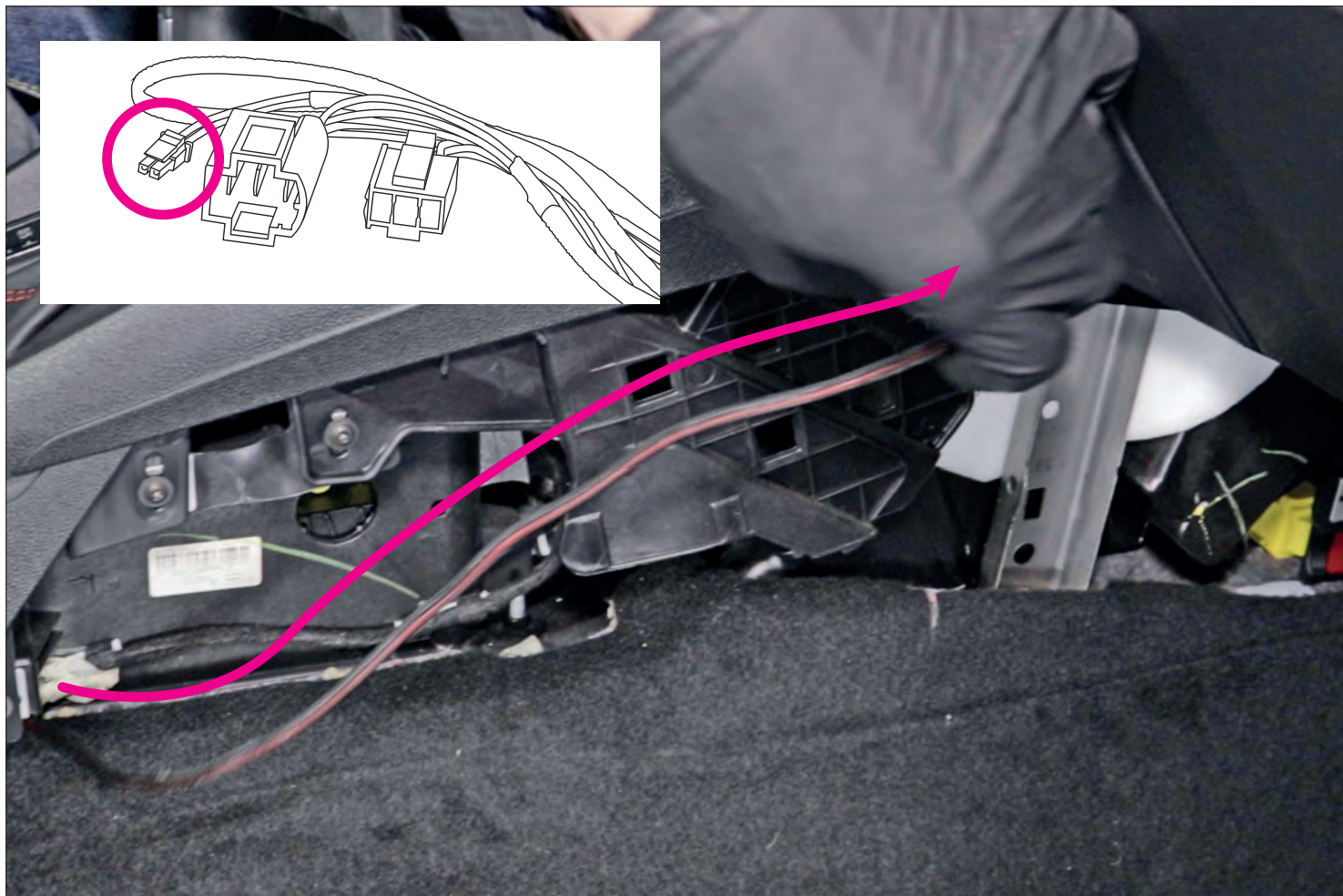
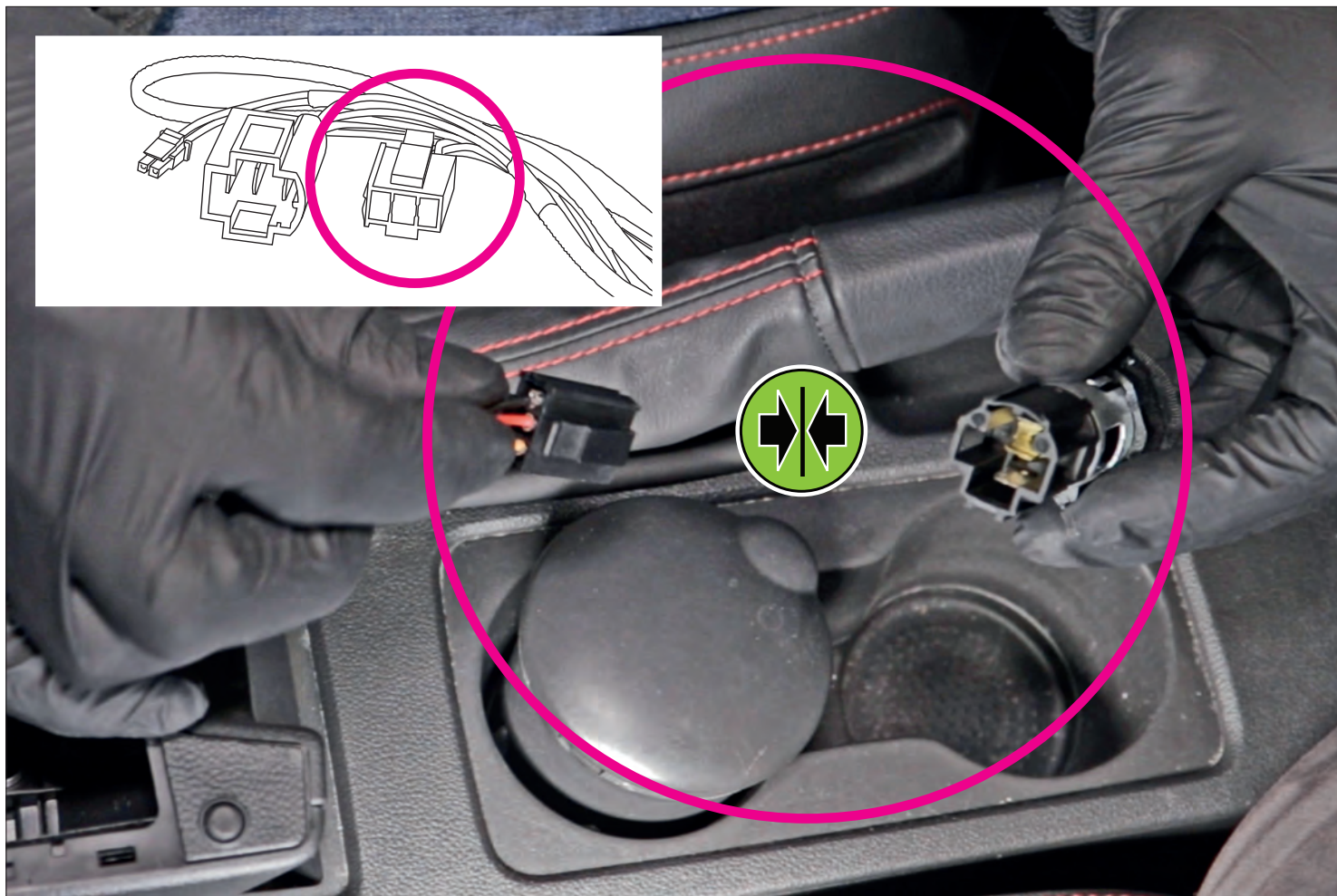



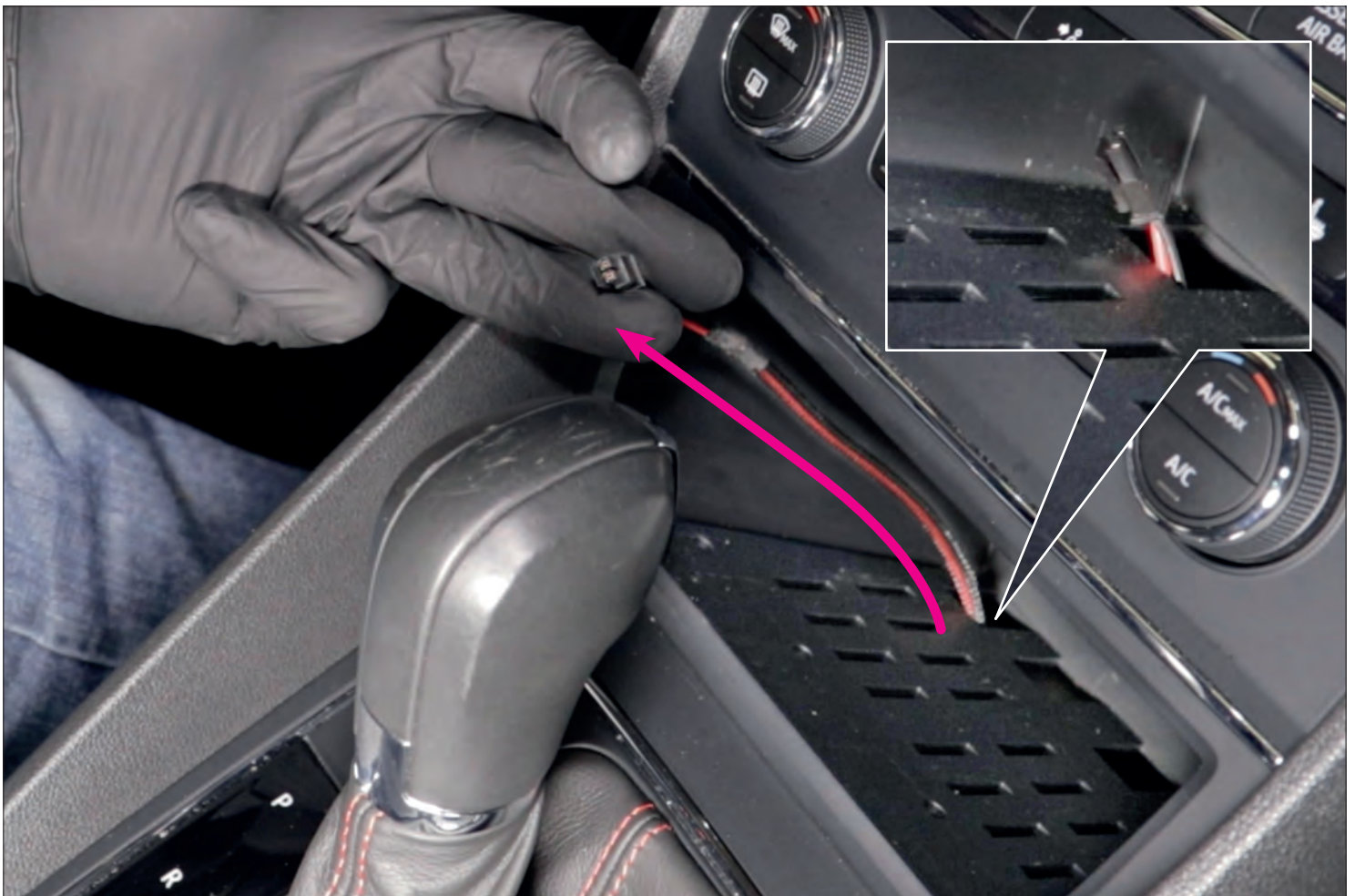

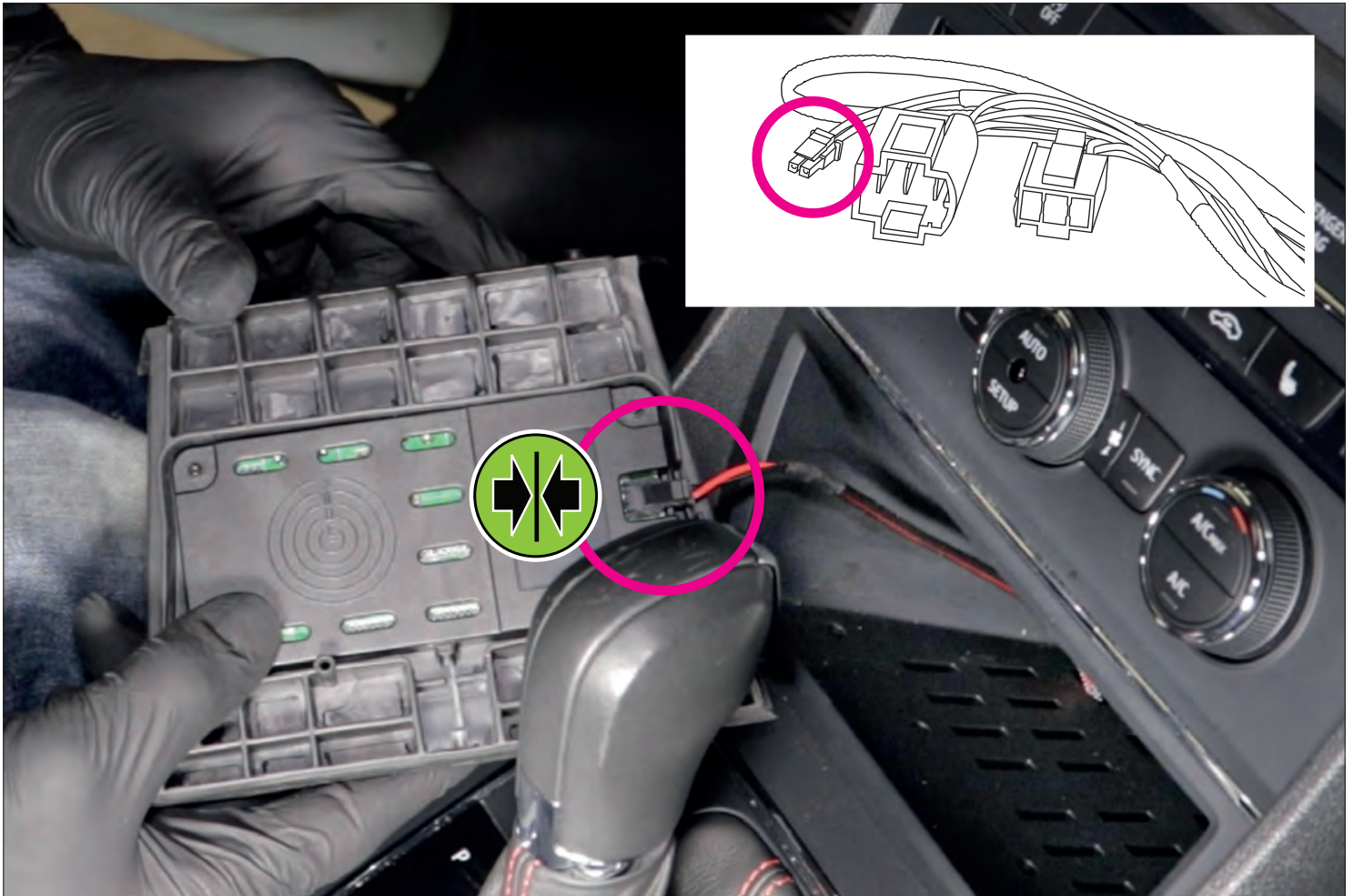

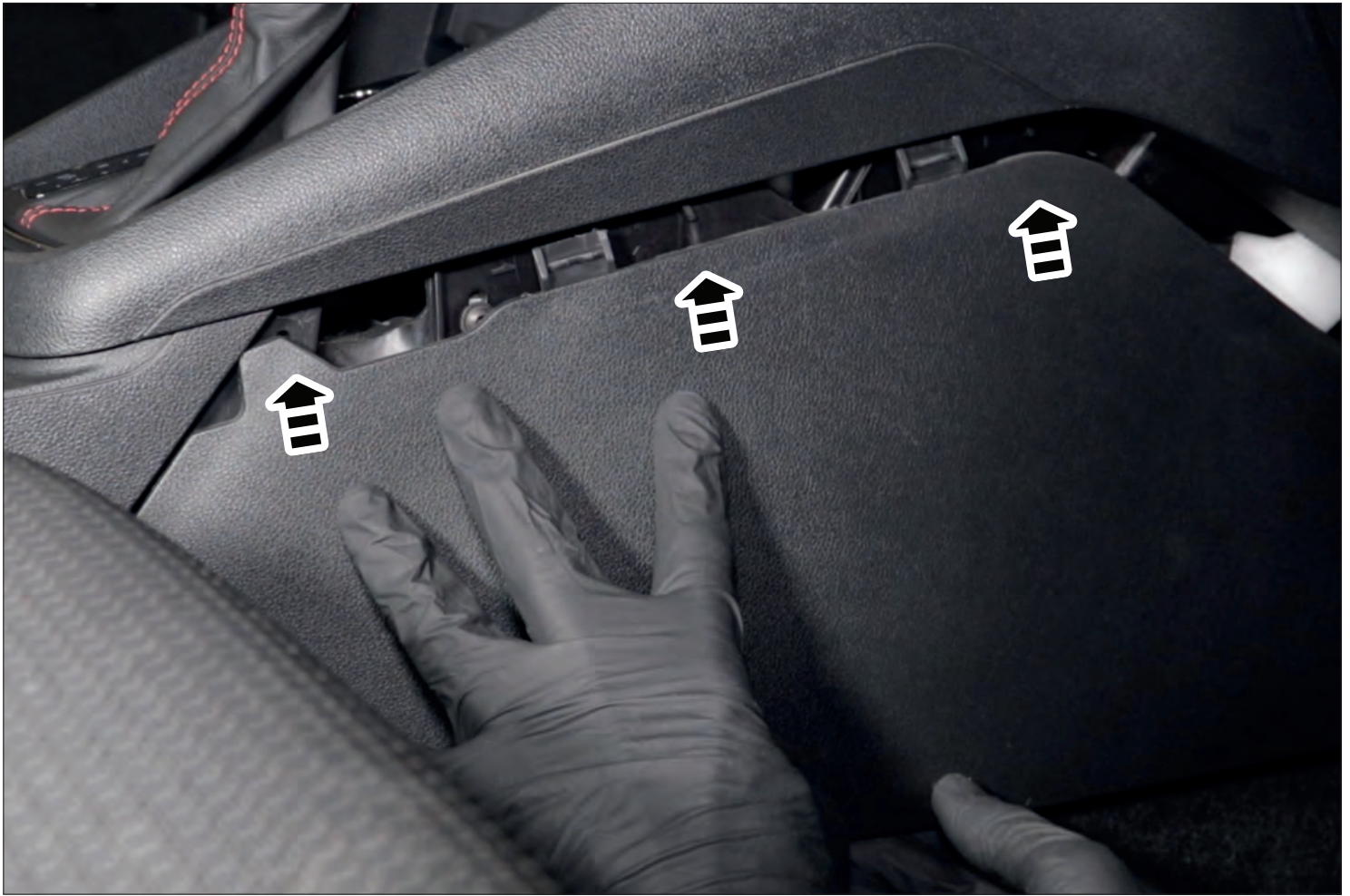



Rote LED  
Red LED



Blaue LED  
Blue LED

